

DISPENSA TANDEM I

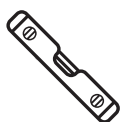

KESSEBÖHMER

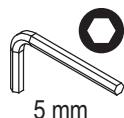
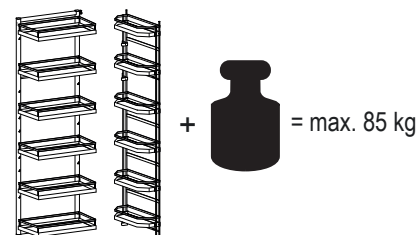
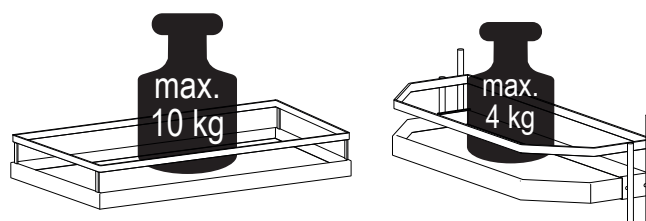
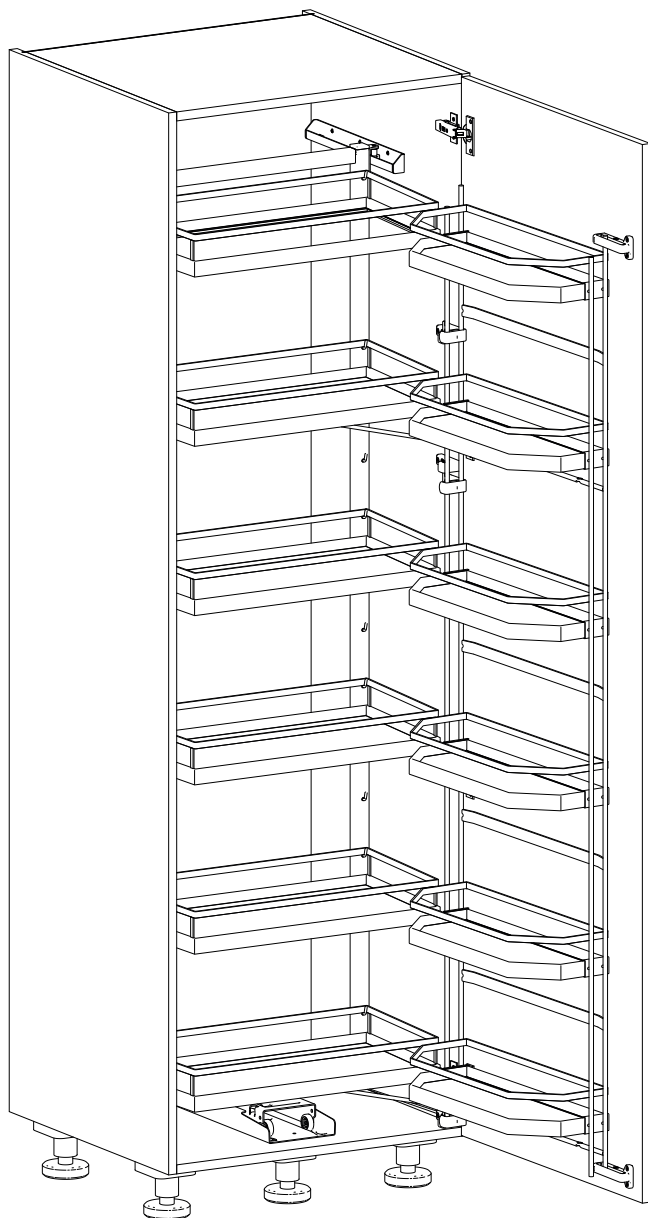

<http://support.kesseboehmer.de>



DISPENSA TANDEM I

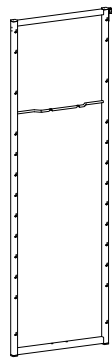

1x

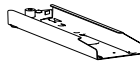

1x

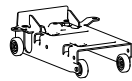

1x

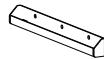

1x



1x



2x

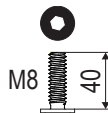
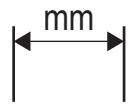

2x

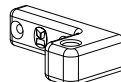

3x / 2x

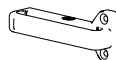

2x



1x

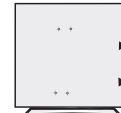

1x



1x

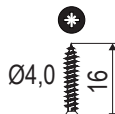

7x

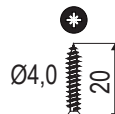

10x

DE Die technischen Darstellungen und Maßangaben – auch bei Abbildungen und Zeichnungen – sind unverbindlich. Konstruktionsverbesserungen sind vorbehalten! **EN** Technical information and stated dimensions (including in illustrations and drawings) must not be regarded as binding. Design subject to improvement without notice! **FR** Les visuels techniques et dimensions – y compris les schémas et les illustrations – ne sont pas contractuelles. Sous réserve d'évolutions techniques! **IT** Le rappresentazioni tecniche e le indicazioni delle dimensioni – anche nelle figure e nei disegni – non sono vincolanti. Con riserva di miglioramenti di progettazione! **ES** Las imágenes técnicas y las indicaciones de medidas – también en imágenes y dibujos – no son vinculantes. Queda reservado el derecho de realizar mejoras en el diseño! **PT** Representações técnicas e dimensões – mesmo em ilustrações e desenhos – não são vinculativas. Reservado o direito a melhorias construtivas! **HE** כל התרשימים הטכניים והמידות – אף לגבי איורים ותכניות – הנם בלתי מחייבים. הנם בלתי מחייבים. **FI** Tekniset piirroksset ja mitat – myös kuvissa ja piirroksissa olevat – ovat sitoumuksetta parantaviin muutoksiin pidätetään! **DA** De tekniske illustrationer og målangivelser - også på illustrationer og tegninger - er ikke bindende. Forbehold for designforbedringer! **CS** Technické popisy a rozměry, jakož i obrázky a výkresy, jsou nezávazné. Vyhrazujeme si právo na změny konstrukce! **PL** Prezentacje techniczne i wymiary – także na ilustracjach i rysunkach – nie są wiążące. Udoskonalenia konstrukcyjne są zastrzeżone! **RU** Иллюстрации технических деталей и указанные размеры, в том числе на рисунках и чертежах, являются ориентировочными. Компания оставляет за собой право на усовершенствование конструкции! **TR** Teknik sunum ve ölçü bilgileri (resim ve çizimlerde de) yasal olarak bağlayıcı değildir. Yapısal geliştirmeler uyarına hakkı saklıdır! **BC** Техническото представяне и размерите, включително при изображенията и чертежите, са необвързващи. Запазваме си правото на конструктивни подобрения! **HU** A műszaki ábrázolások és méretadatok – ábránál és rajzoknál sem – nem kötelező érvényűek. A konstrukciós javítások joga fenntartva! **SR** Tehničke ilustracije i dimenzije - uključujući ilustracije i crteže - nisu obavezujući. Dizajn poboljšanja su rezervisana! **EL** Τα τεχνικά σχέδια και οι διαστάσεις – ακόμα και σε απεικονίσεις και σχέδια – δεν είναι δεσμευτικά. Με την επιφύλαξη τεχνικών βελτιώσεων! **AR** الرسوم التوضيحية والأبعاد الفنية - مما في ذلك الرسوم التوضيحية والرسومات - ليست إلزامية. الحق محفوظ في إجراء تحسينات هيكليّة! **JA** 生みにくさが高じれ **CN** 技术说明和规格, 包括插图和图纸均不具约束力。保留改进设计的权利!

DISPENSA TANDEM I



1

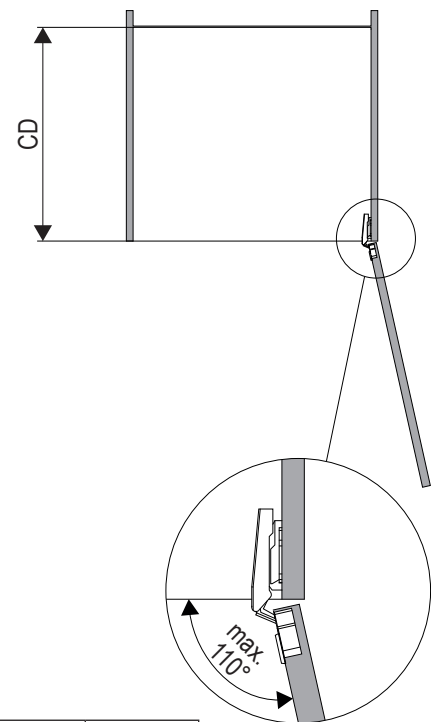
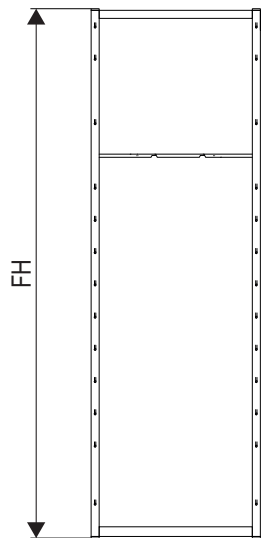
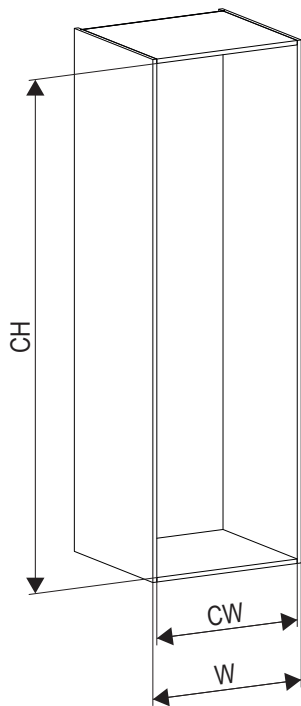
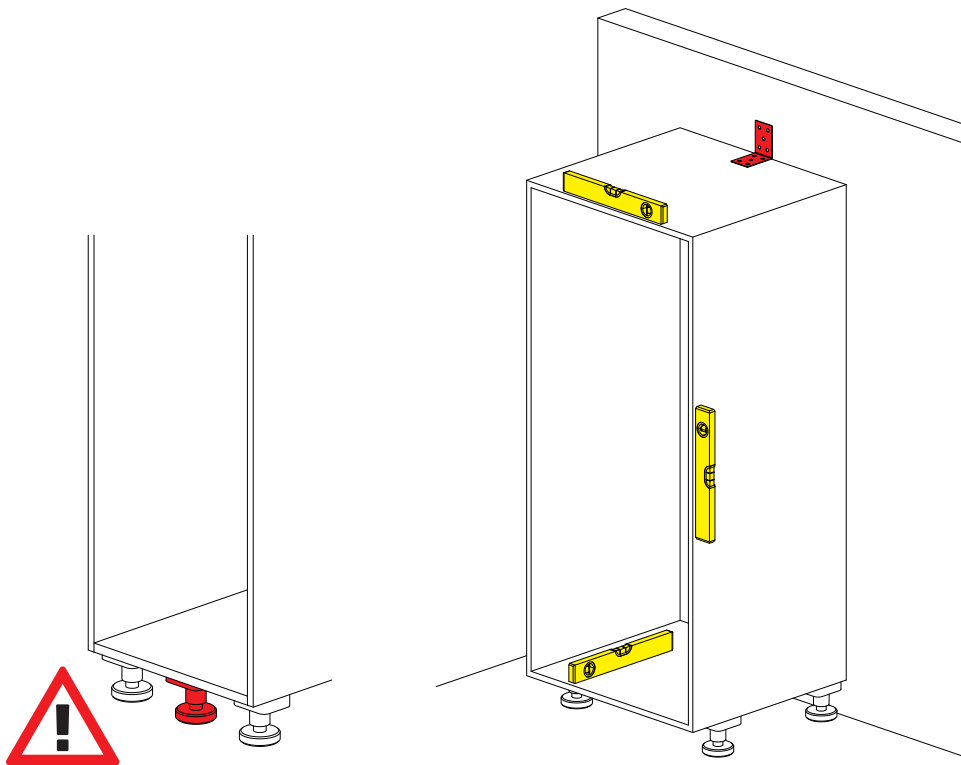
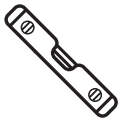

W	FH	CH	CW	CD
450	1032	≥ 1100	412 - 418	≥ 500
450	1632	≥ 1700	412 - 418	≥ 500
500	1032	≥ 1100	462 - 468	≥ 500
500	1632	≥ 1700	462 - 468	≥ 500
600	732	≥ 800	562 - 568	≥ 500
600	1032	≥ 1100	562 - 568	≥ 500
600	1632	≥ 1700	562 - 568	≥ 500

DISPENSA TANDEM I



2

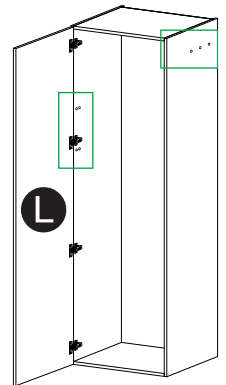
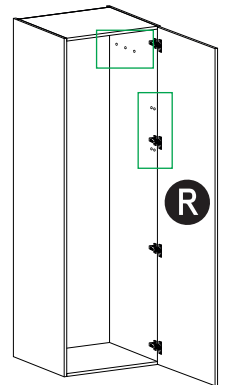
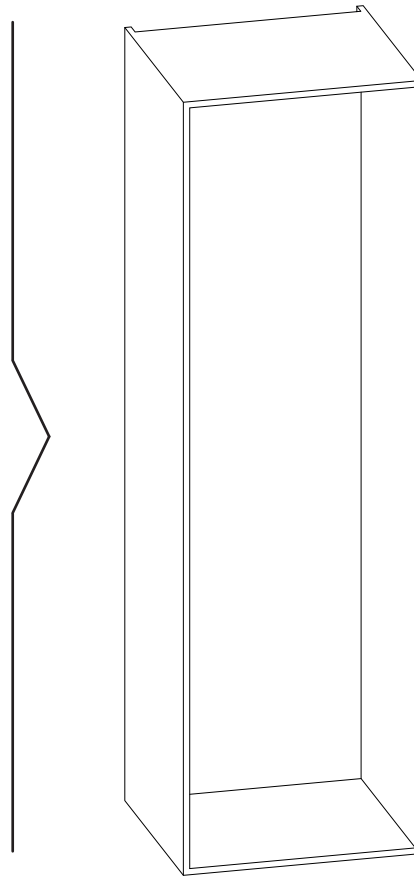
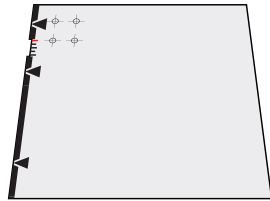
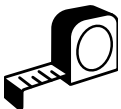

3

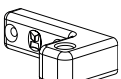

2x / 1x

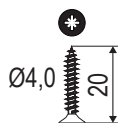

4x / 2x



L

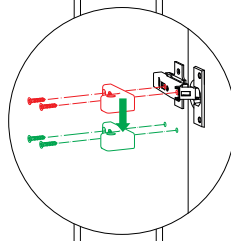
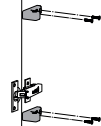

R

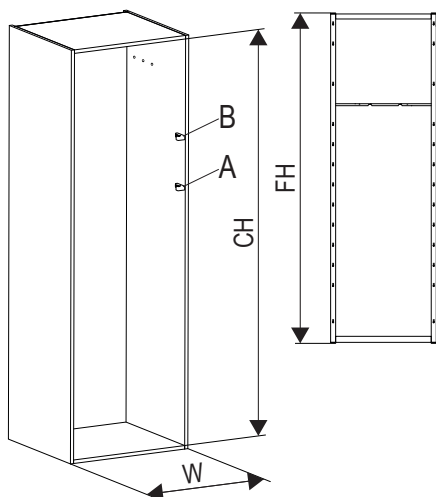
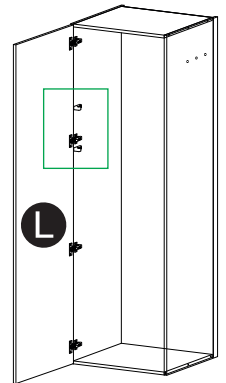
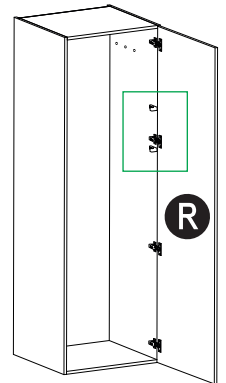
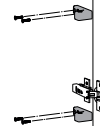

FH	CH	W	A	B
732	≥ 800	600	1	X
1032	≥ 1100	450 / 500	1	X
		600	1	1
1632	≥ 1700	450 / 500	1	X
		600	1	1

DISPENSA TANDEM I



4

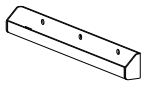

1x

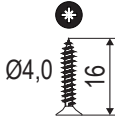

3x



PZ2

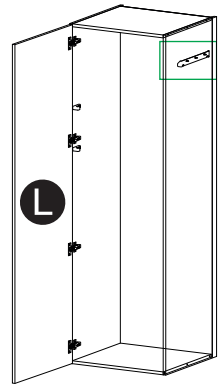
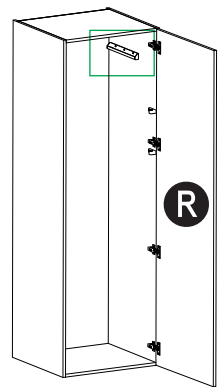
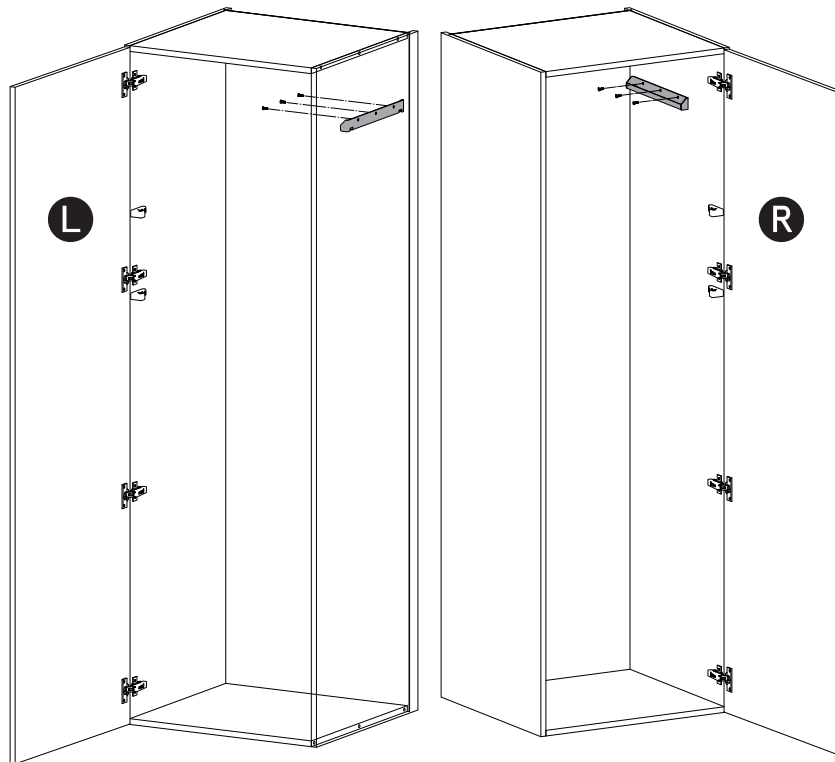

5

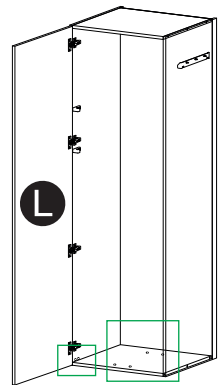
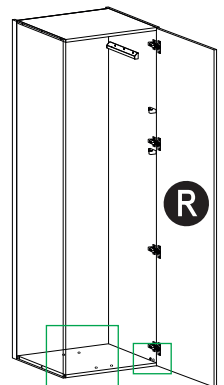
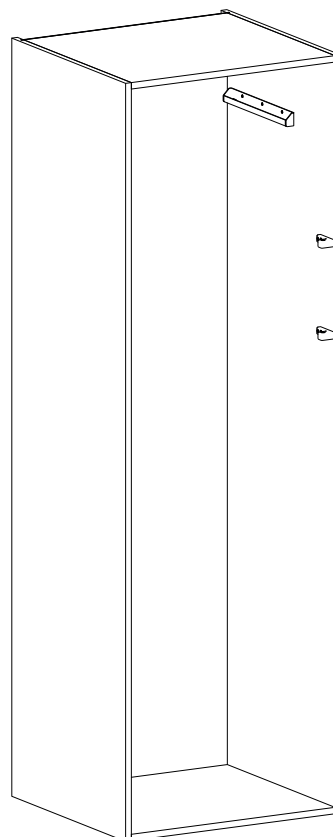
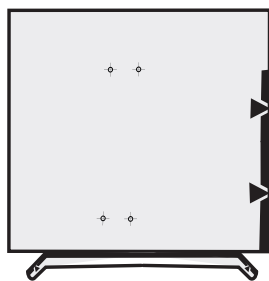
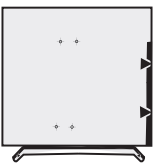

DISPENSA TANDEM I



6

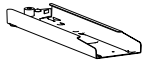

1x

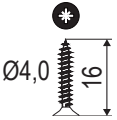

4x

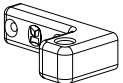

1x

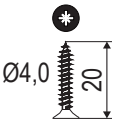

2x



PZ2

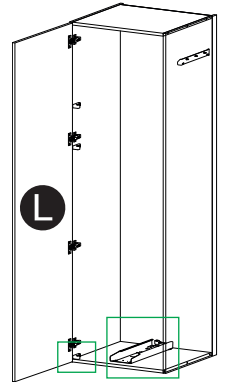
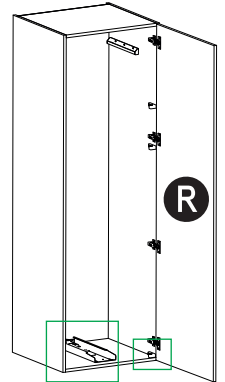
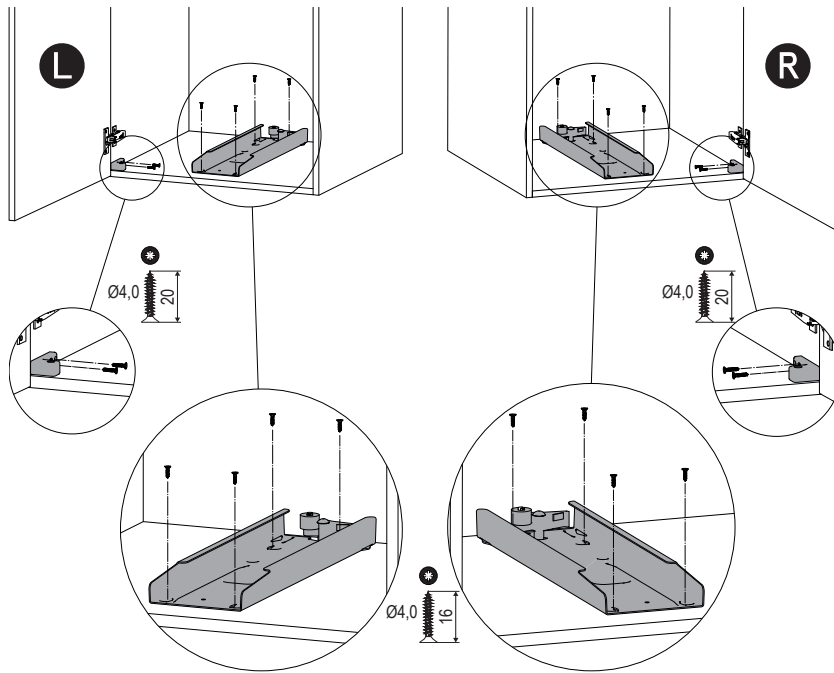

7

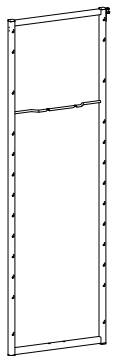

1x

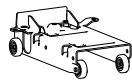

1x

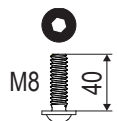

2x

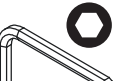

5 mm

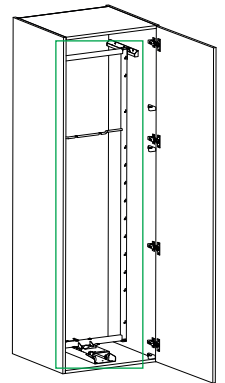
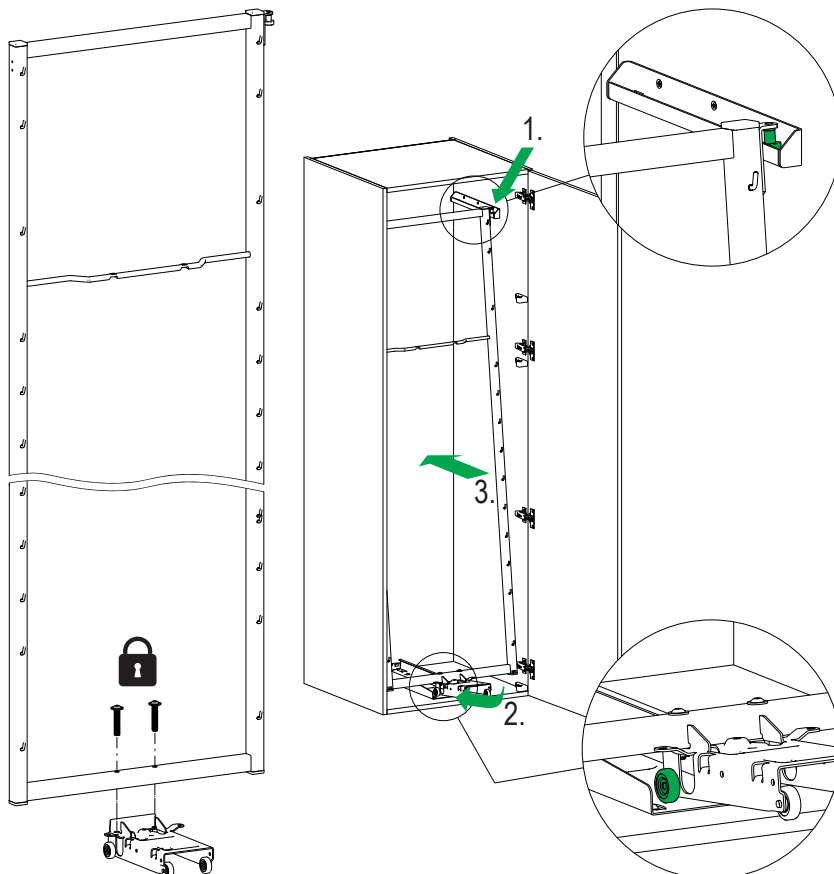

DISPENSA TANDEM I



8



1x

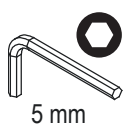

5 mm

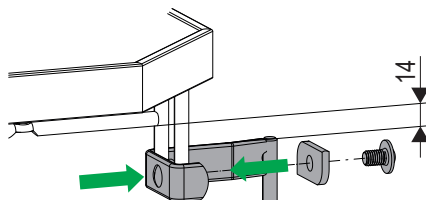
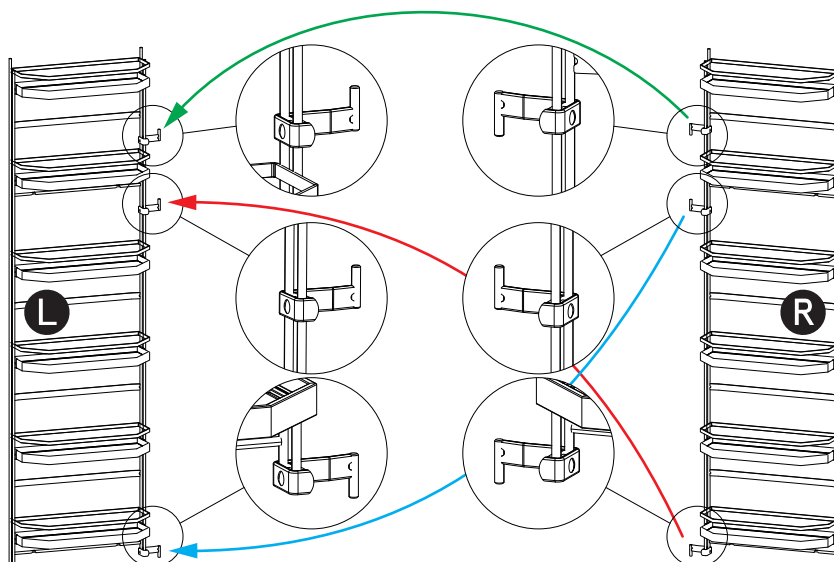
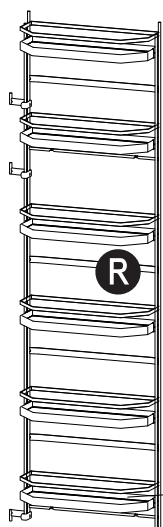
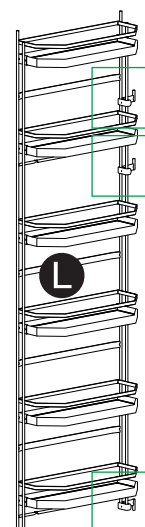
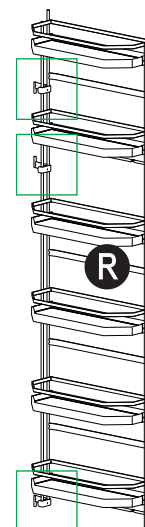
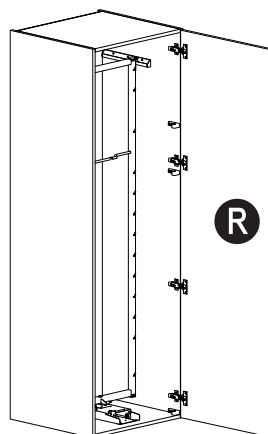
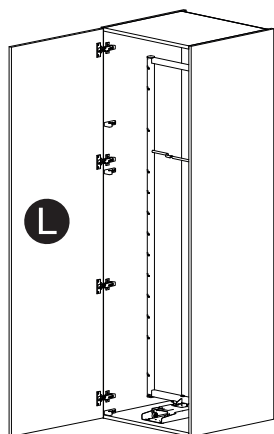

DISPENSA TANDEM I



9



1x

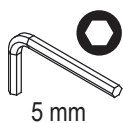

5 mm

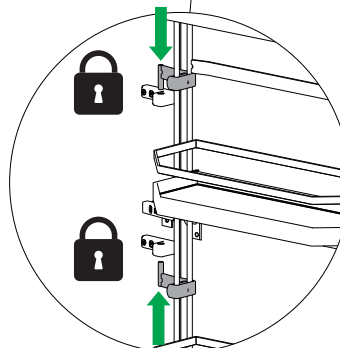
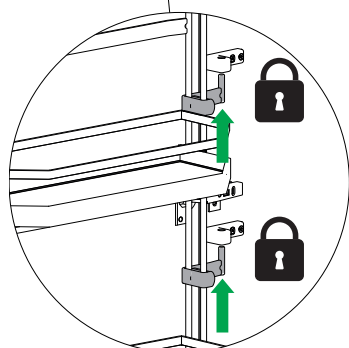
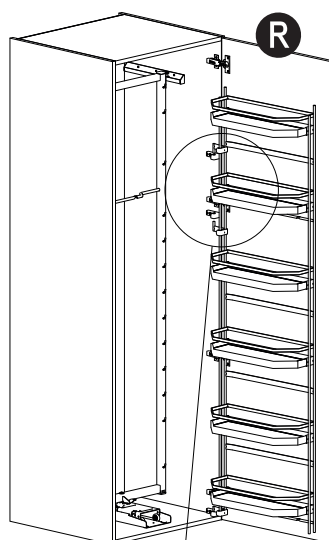
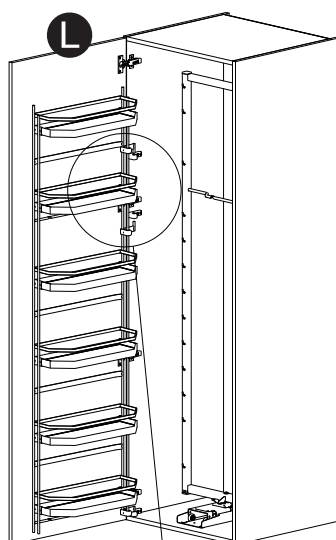
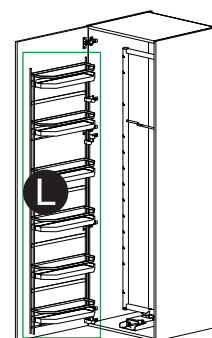
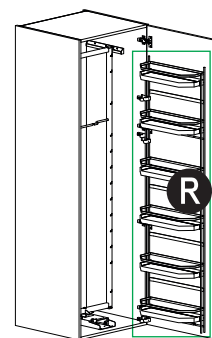
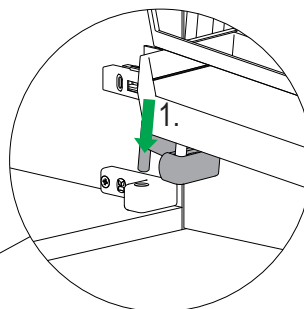
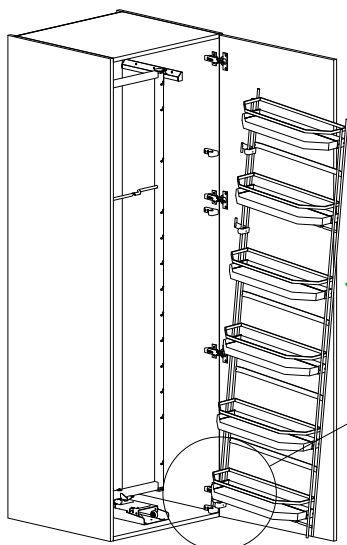

DISPENSA TANDEM I



10



1x

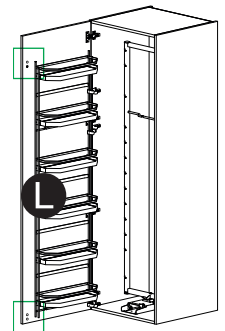
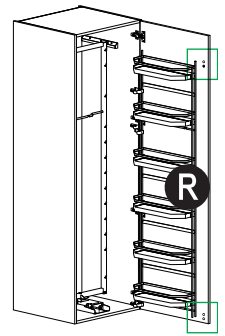
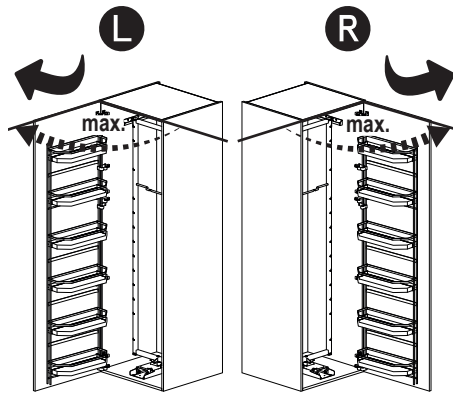
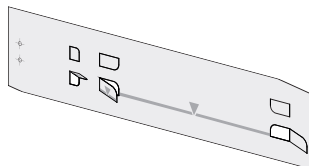

11

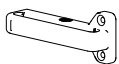

2x

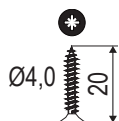

4x

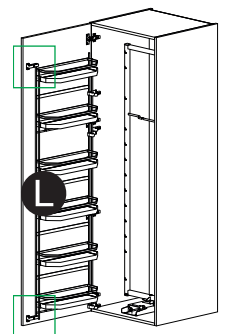
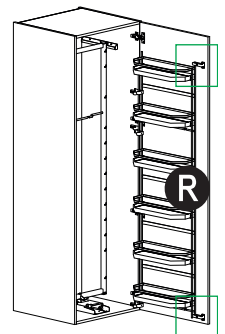
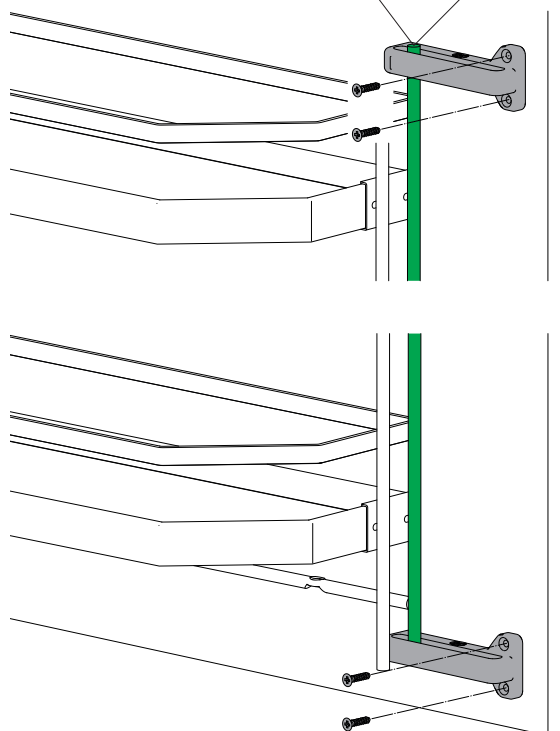
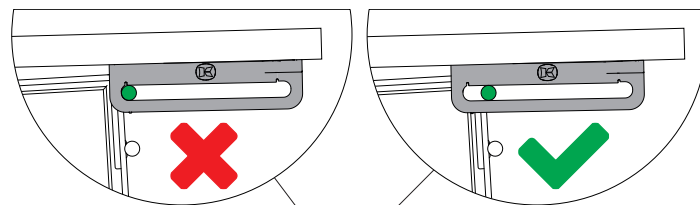

DISPENSA TANDEM I



12

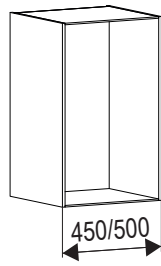

12a

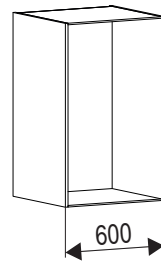

12b

12a

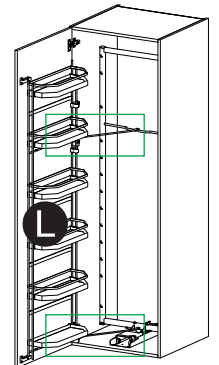
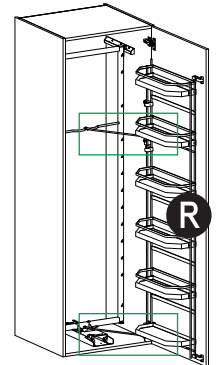
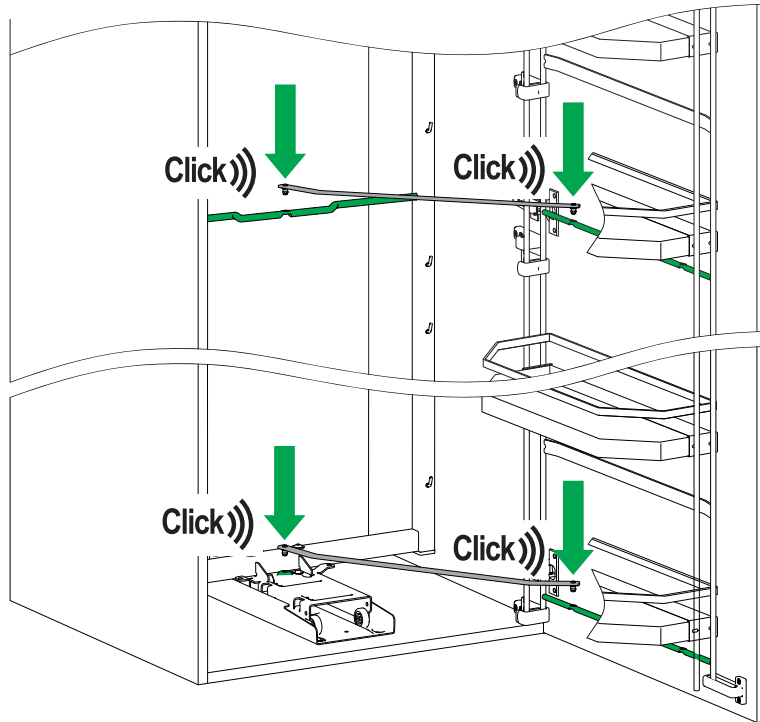
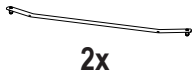

12b

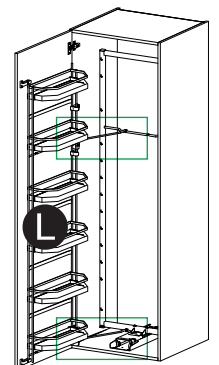
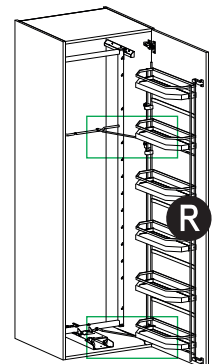
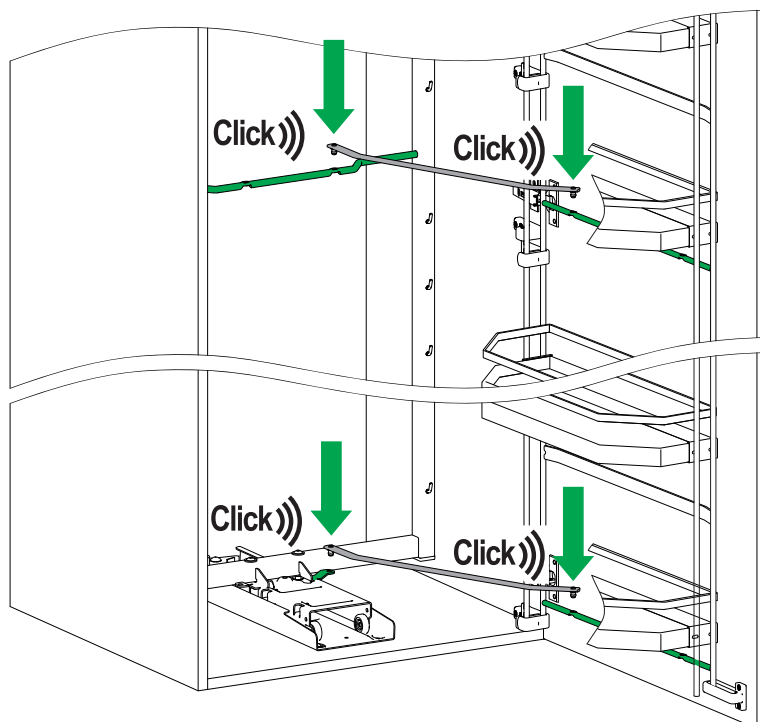
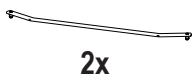

Für links scharnierte
Tür spiegelbildlich.
For left mounted door
mirror image.

DISPENSA TANDEM I



i

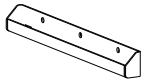
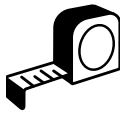

1x

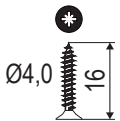

3x



PZ2

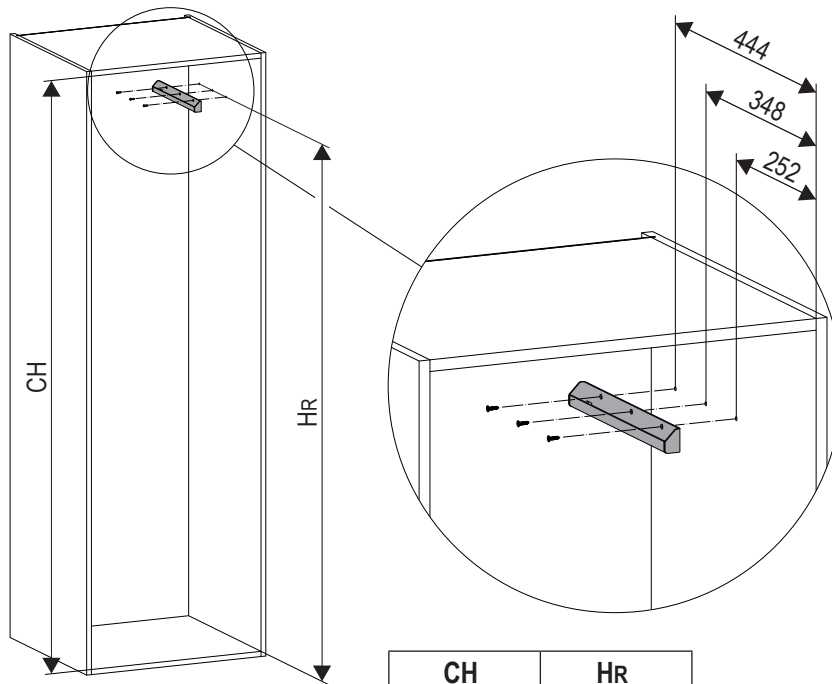

CH	HR
≥ 800	775
≥ 1100	1075
≥ 1700	1675

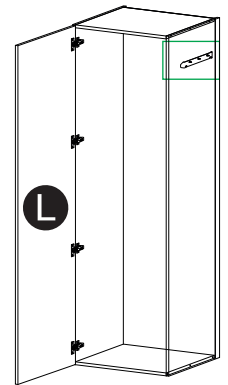
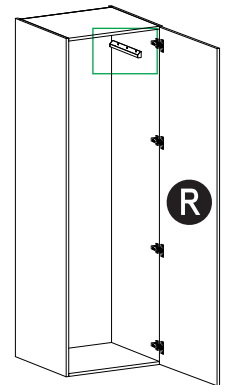

i

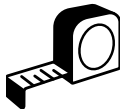

1x

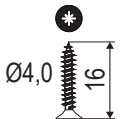

4x



PZ2

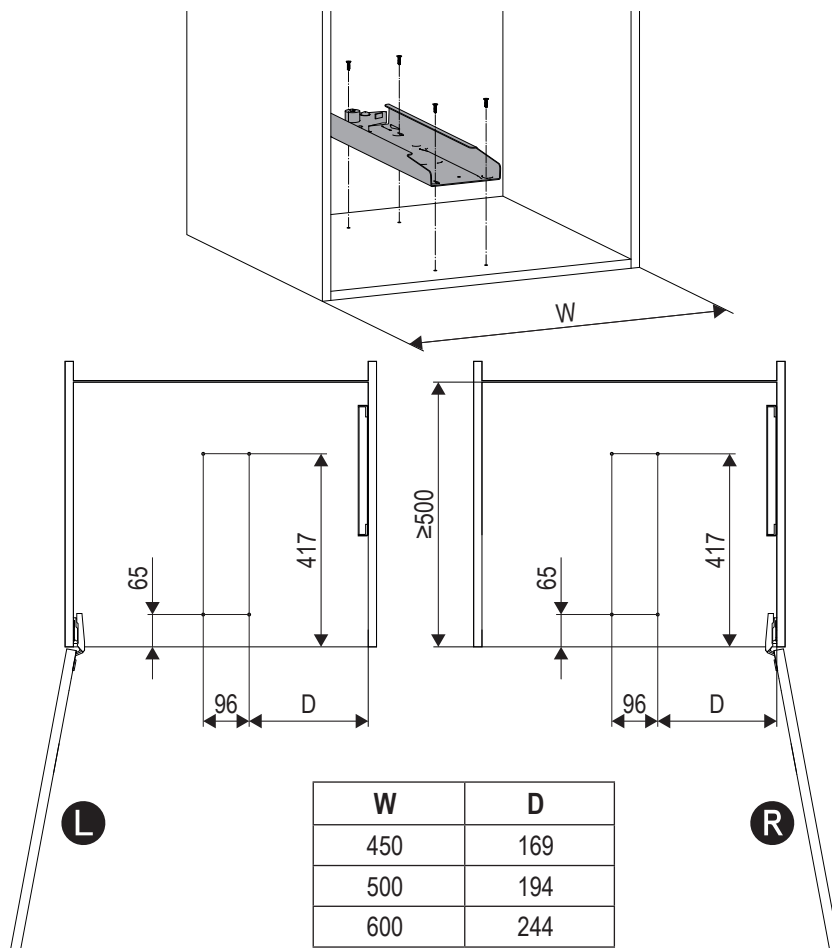

W	D
450	169
500	194
600	244

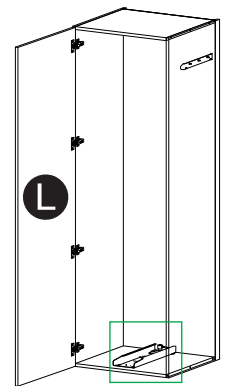
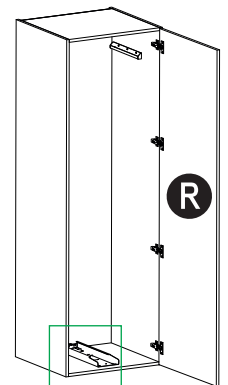

DISPENSA TANDEM I



i

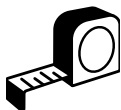

3x / 2x

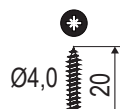

6x / 4x

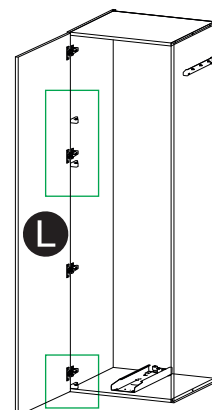
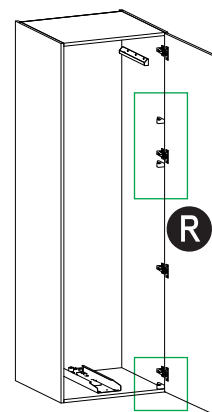
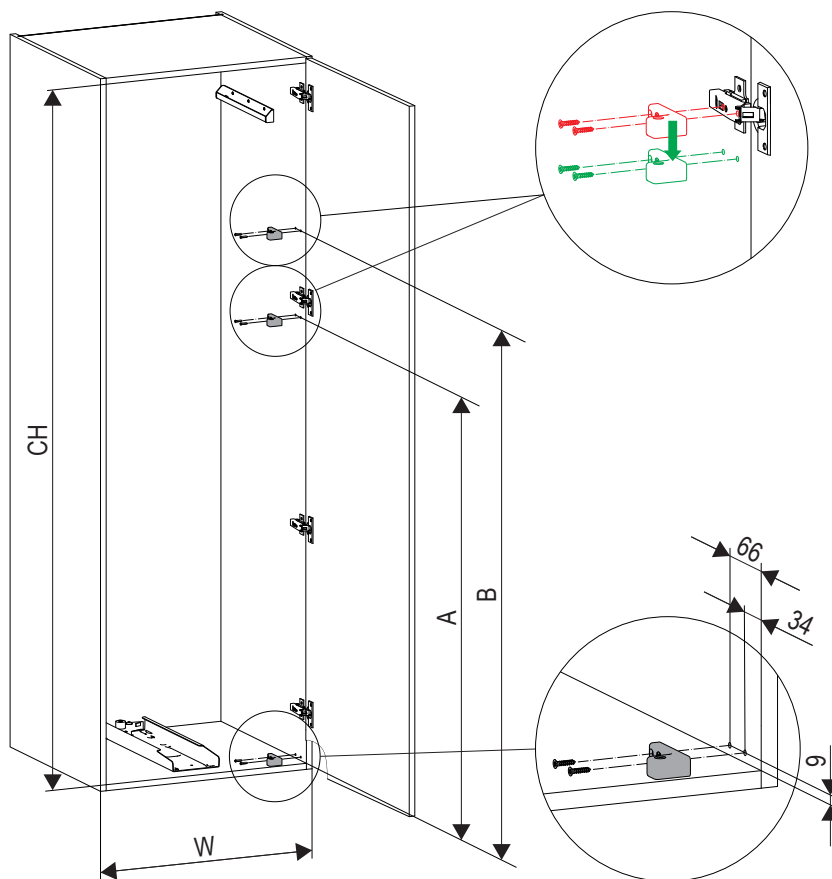

CH	W	A	B
≥ 800	600	625	X
≥ 1100	450 / 500	625	X
	600	625	815
≥ 1700	450 / 500	1225	X
	600	1225	1415

DISPENSA TANDEM I



i



2x



Ø4,0
20

4x



PZ2

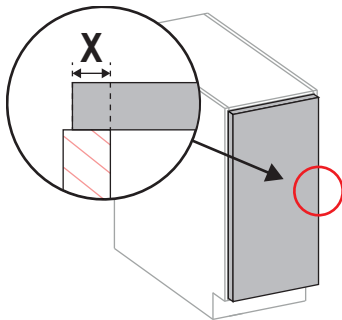
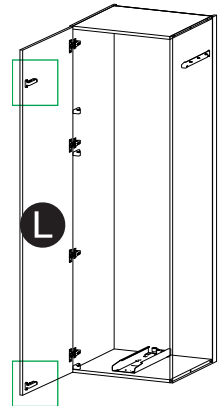
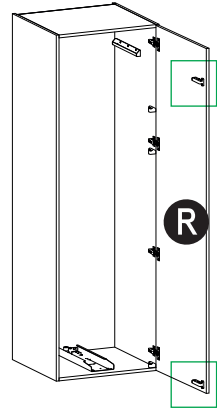
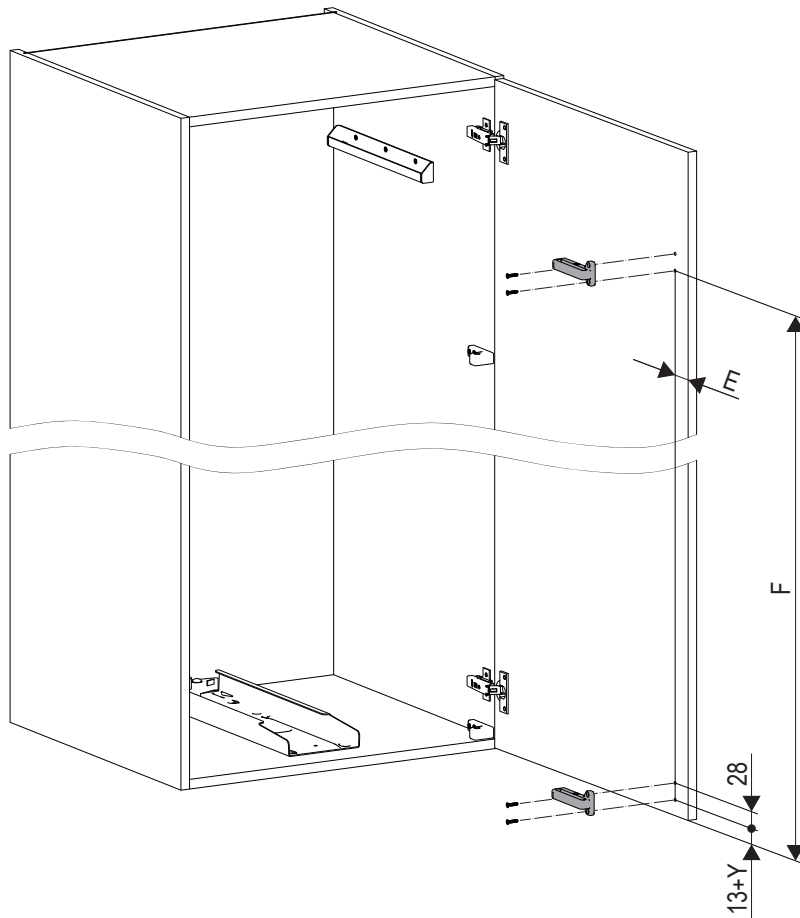

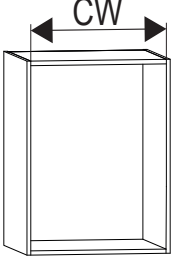
	CW	E
	412 - 418	CW-397+X
	462 - 468	CW-447+X
	562 - 568	CW-547+X

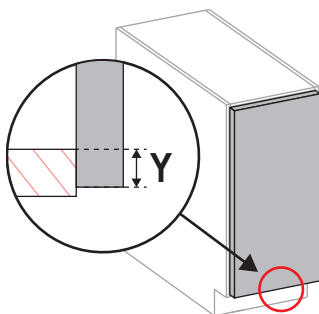

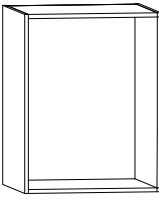
	CH	F
	≥ 800	759+Y
	≥ 1100	1059+Y
	≥ 1700	1629+Y

DISPENSA TANDEM I DEPOT



i

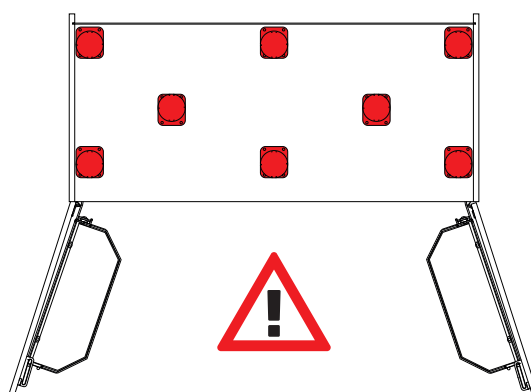
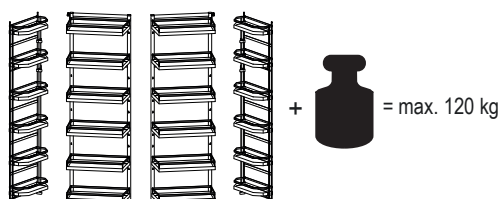
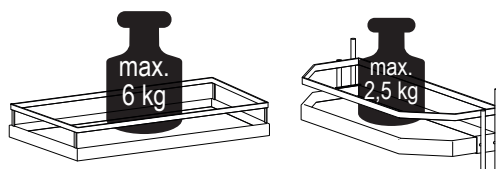
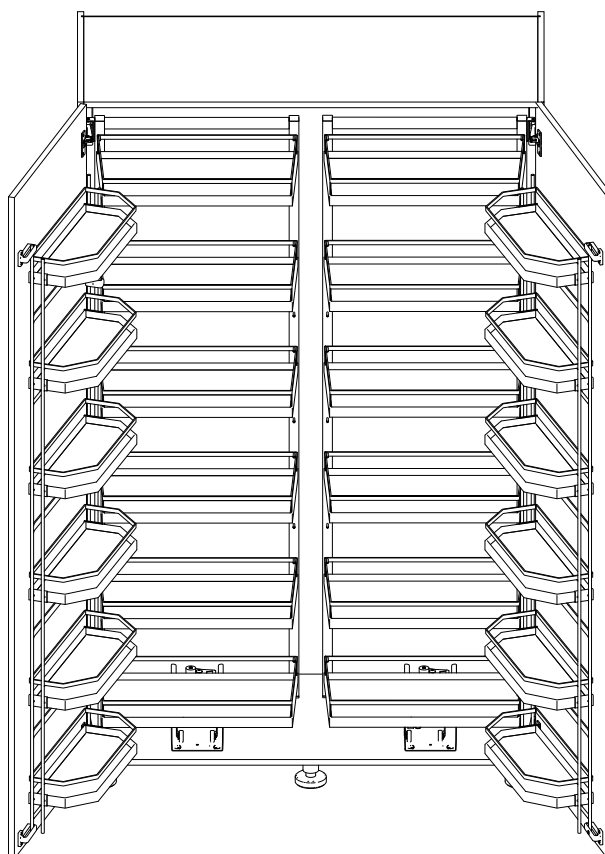

DISPENSA TANDEM I DEPOT



13

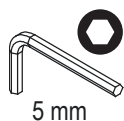

5 mm



PZ2

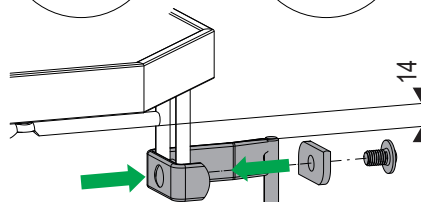
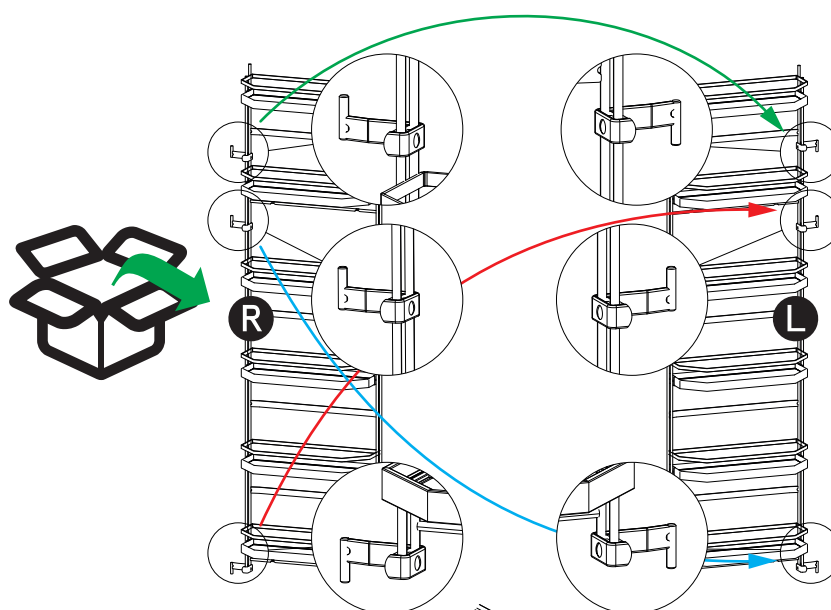
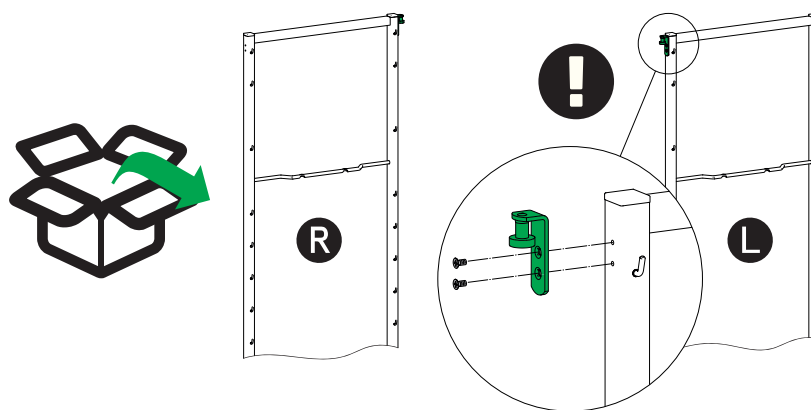
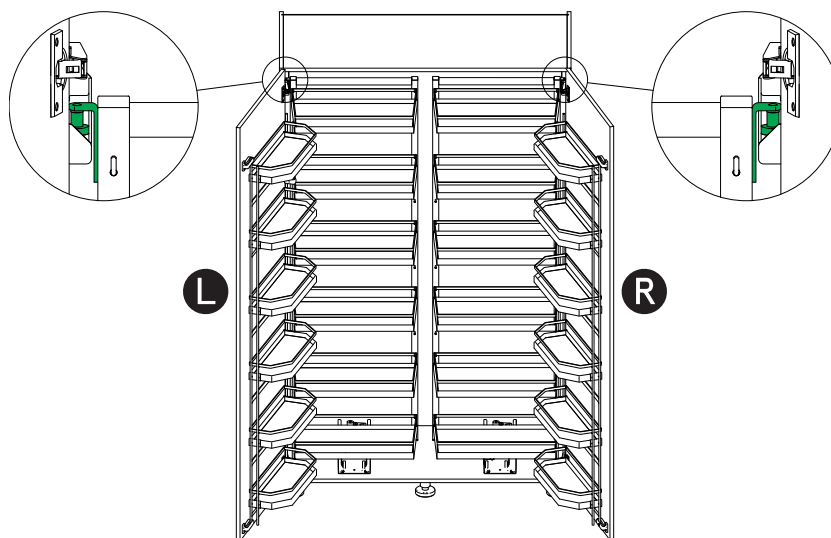

DISPENSA TANDEM I DEPOT



i

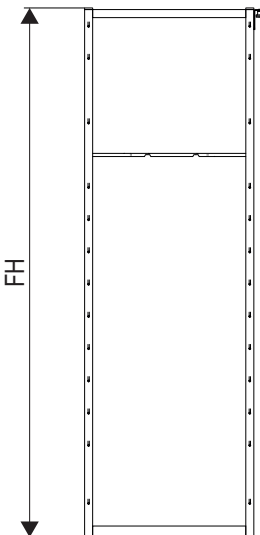
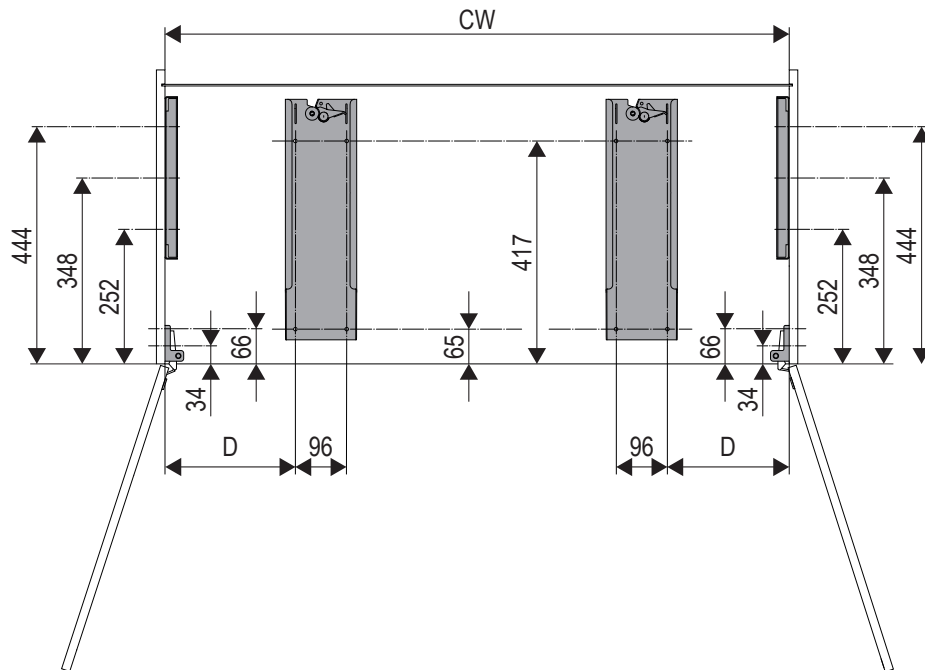
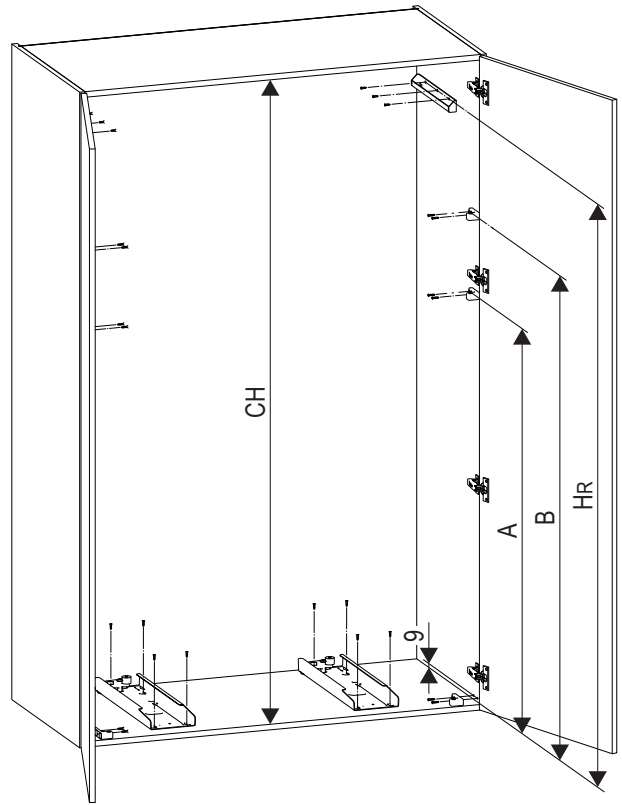
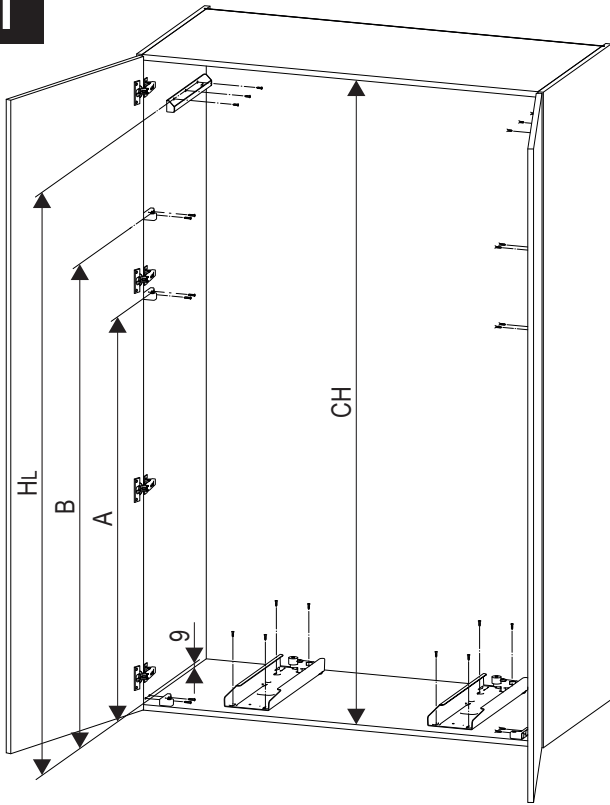

FH	CH	CW	A	B	HR	HL	D
732	≥ 800	≥ 856	625	X	775	775	169
1032	≥ 1100	≥ 956	625	815	1075	1075	194
1632	≥ 1700	≥ 1156	1225	1415	1675	1675	244