

# TANDEM diagonal junior

250 mm

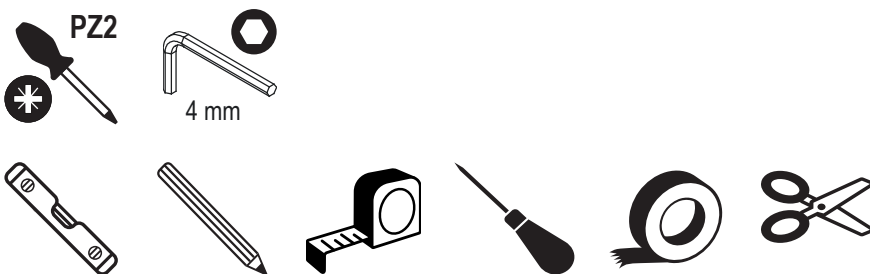

<https://support.kesseboehmer.de>

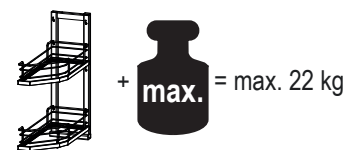
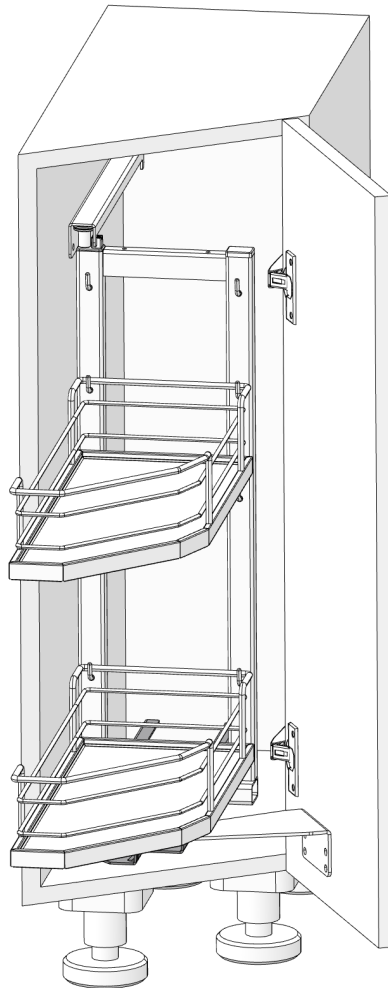

# TANDEM diagonal junior

250 mm

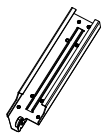
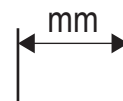

1x



1x

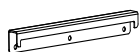

1x

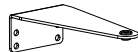

1x

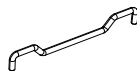

1x



1x



1x



1x



1x



2x

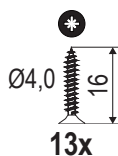

13x

**DE** Die technischen Darstellungen und Maßangaben – auch bei Abbildungen und Zeichnungen – sind unverbindlich. Konstruktionsverbesserungen sind vorbehalten! **EN** Technical information and stated dimensions (including in illustrations and drawings) must not be regarded as binding. Design subject to improvement without notice! **FR** Les visuels techniques et dimensions – y compris les schémas et les illustrations – ne sont pas contractuelles. Sous réserve d'évolutions techniques! **IT** Le rappresentazioni tecniche e le indicazioni delle dimensioni – anche nelle figure e nei disegni – non sono vincolanti. Con riserva di miglioramenti di progettazione! **ES** Las imágenes técnicas y las indicaciones de medidas – también en imágenes y dibujos – no son vinculantes. Queda reservado el derecho de realizar mejoras en el diseño! **PT** Representações técnicas e dimensões – mesmo em ilustrações e desenhos – não são vinculativas. Reservado o direito a melhorias construtivas! **HE** כל התרשימים הטכניים והמידות – אף לגבי איורים ותכניות – הנם בלתי מחייבים. **FI** Tekniset piirroksset ja mitat – myös kuvissa ja piirroksissa olevat – ovat sitoumuksetta. Oikeus rakennetta parantaviin muutoksiin pidätetään! **DA** De tekniske illustrationer og målangivelser – også på illustrationer og tegninger – er ikke bindende. Forbehold for designforbedringer! **CS** Technické popisy a rozměry, jakož i obrázky a výkresy, jsou nezávazné. Vyhrazujeme si právo na změny konstrukce! **PL** Prezentacje techniczne i wymiary – także na ilustracjach i rysunkach – nie są wiążące. Udoskonalenia konstrukcyjne są zastrzeżone! **RU** Иллюстрации технических деталей и указанные размеры, в том числе на рисунках и чертежах, являются ориентировочными. Компания оставляет за собой право на усовершенствование конструкции! **TR** Teknik sunum ve ölçü bilgileri (resim ve çizimlerde de) yasal olarak bağlayıcı değildir. Yapısal geliştirmeler uyarına hakkı saklıdır! **BG** Техническото представяне и размерите, включително при изображенията и чертежите, са необвързващи. Запазваме си правото на конструктивни подобрения! **HU** A műszaki ábrázolások és méretadatok – ábránál és rajzoknál sem – nem kötelező érvényűek. A konstrukciós javítások joga fenntartva! **SR** Tehničke ilustracije i dimenzije – uključujući ilustracije i crteže – nisu obavezujući. Dizajn poboljšanja su rezervisana! **EL** Τα τεχνικά σχήματα και οι διαστάσεις – ακόμα και σε απεικονίσεις και σχέδια – δεν είναι δεσμευτικά. Με την επιφύλαξη τεχνικών βελτιώσεων! **AR** الرسوم التوضيحية والأبعاد الفنية – مما في ذلك الرسوم التوضيحية والرسومات – ليست إلزامية. الحق محفوظ في إجراء تحسينات هيكلية! **JA** 生みにくさが高じれ **CN** 技术说明和规格, 包括插图和图纸均不具约束力。保留改进设计的权利!

# TANDEM diagonal junior

250 mm



i

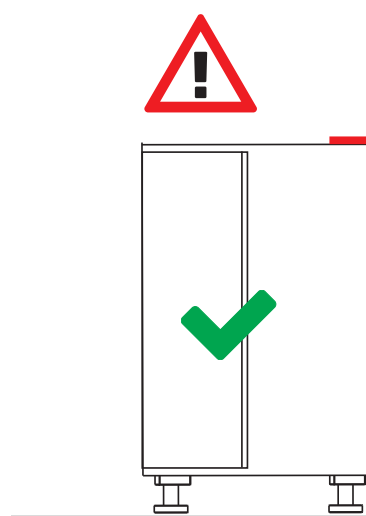
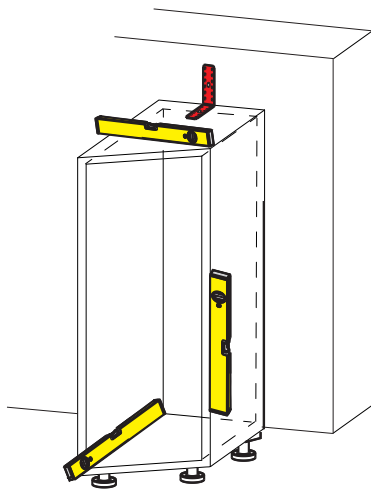

i

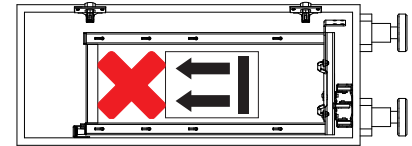
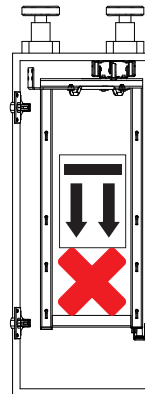
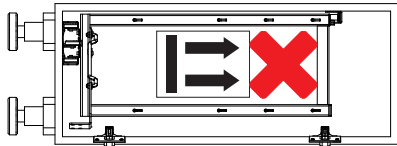
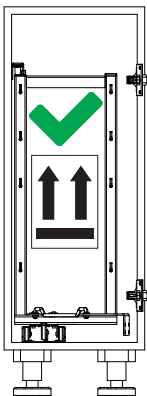

i

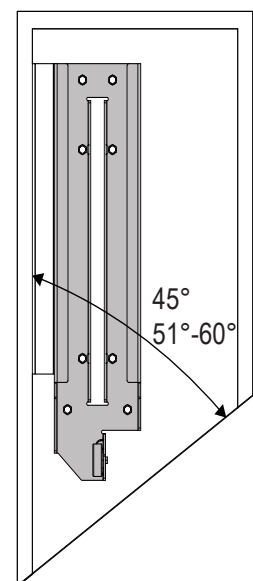
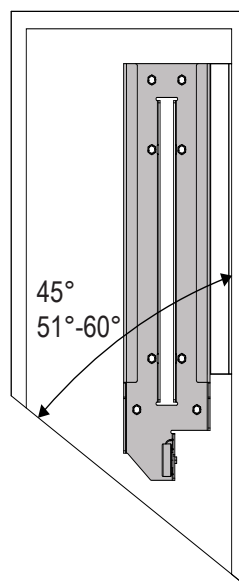
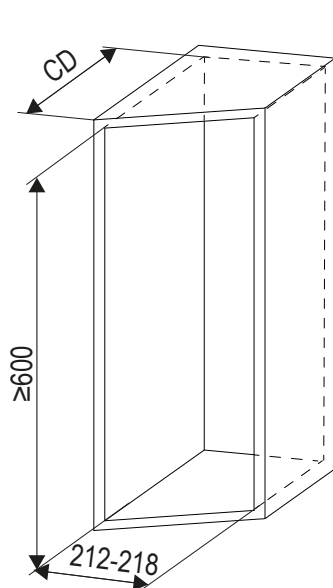

# TANDEM diagonal junior

250 mm



1

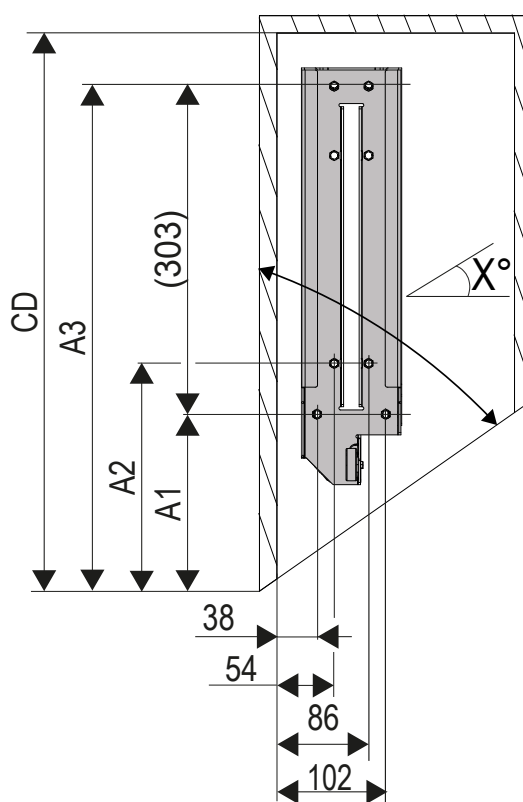
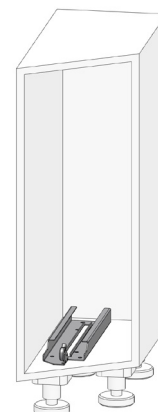
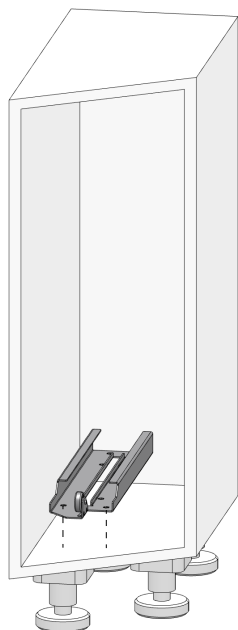
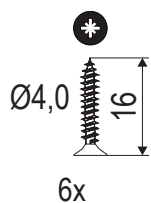
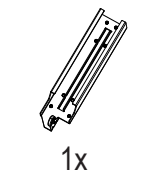

X°	A1	A2	A3	CD
51°	175	222	478	500
52°	173	220	476	498
53°	171	218	474	496
54°	169	216	472	494
55°	167	214	470	492
56°	165	212	468	490
57°	163	210	466	488
58°	161	208	464	486
59°	159	206	462	484
60°	157	204	460	482

# TANDEM diagonal junior

250 mm



**2**

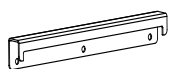

1x

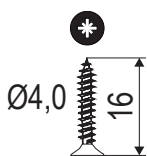

3x

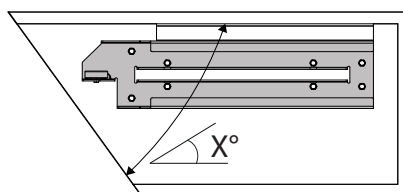
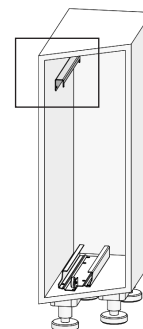
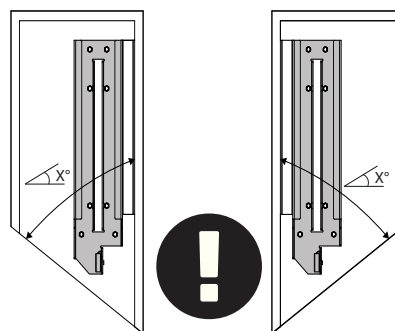
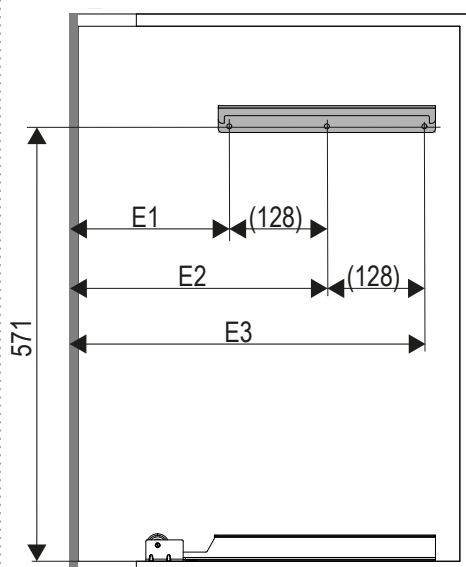

$X^\circ$	E1	E2	E3
51°	227	355	483
52°	225	353	481
53°	223	351	479
54°	221	349	477
55°	219	347	475
56°	217	345	473
57°	215	343	471
58°	213	341	469
59°	211	339	467
60°	209	337	465

**3**

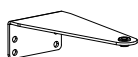

1x

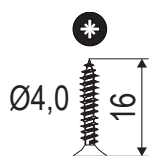

4x

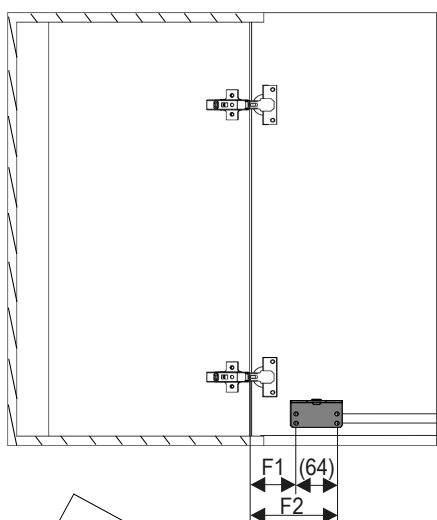

$X^\circ$	F1	F2
51°	75	139
52°	73	137
53°	71	135
54°	69	133
55°	67	131
56°	65	129
57°	63	127
58°	61	125
59°	59	123
60°	57	121

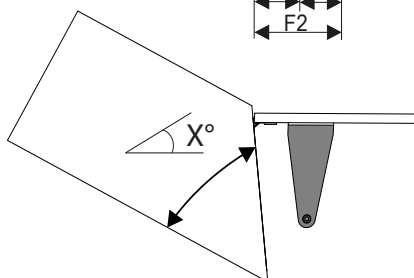
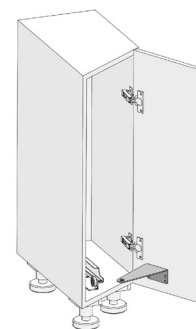

# TANDEM diagonal junior

## 250 mm



4

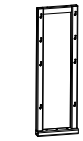

1x



1x



1x

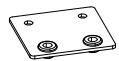

1x



2x



1x

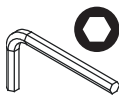

4 mm

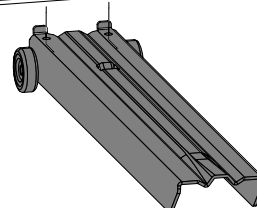
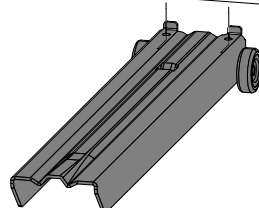
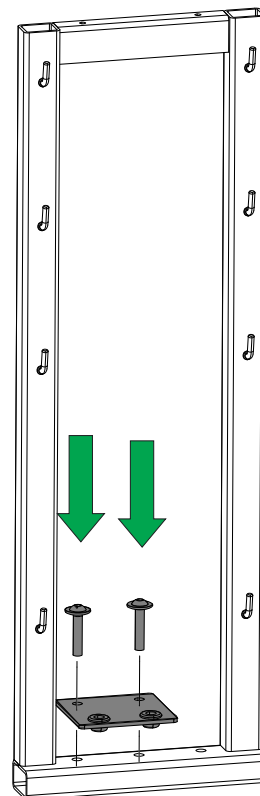
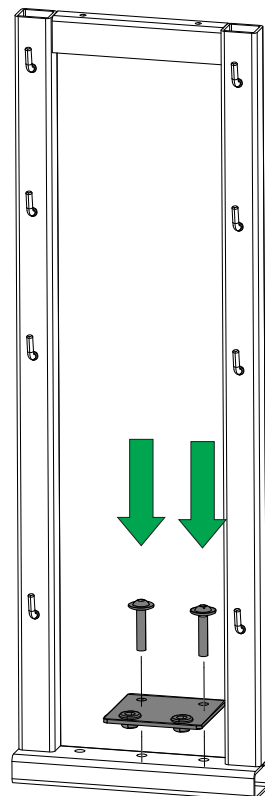
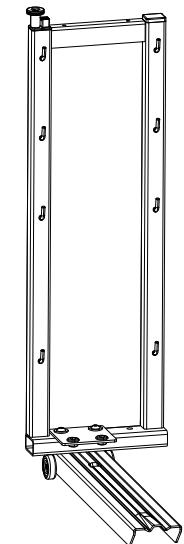
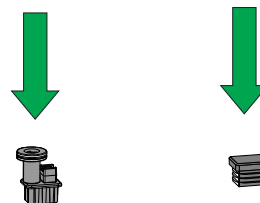
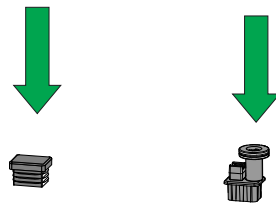
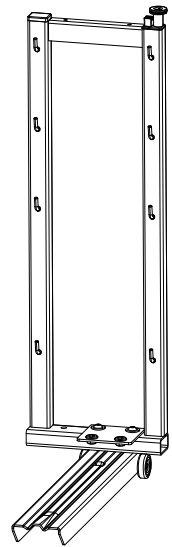
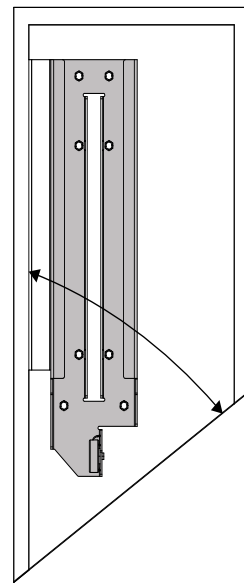
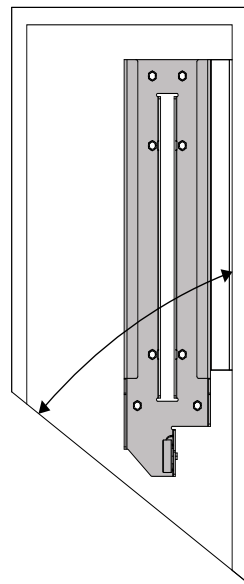

# TANDEM diagonal junior

250 mm



5

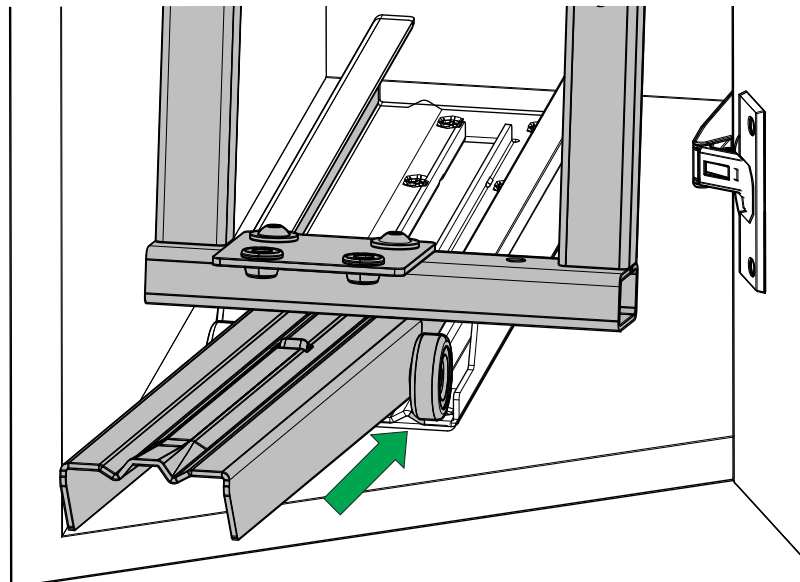
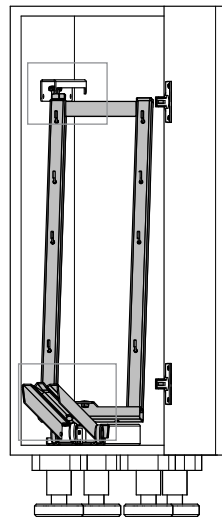
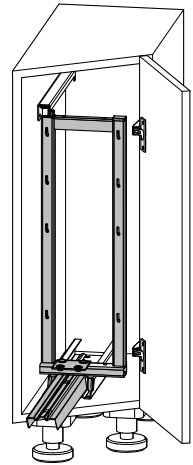
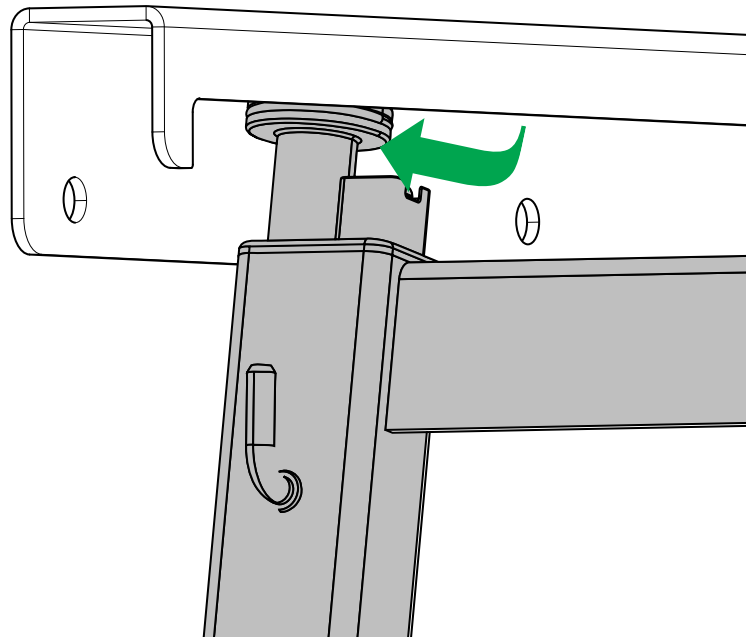
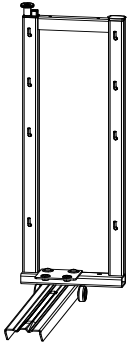

# TANDEM diagonal junior

250 mm



6

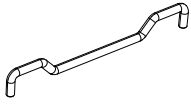

1x

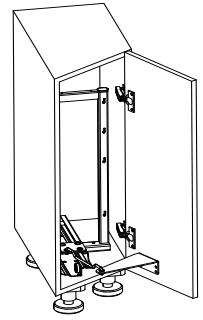
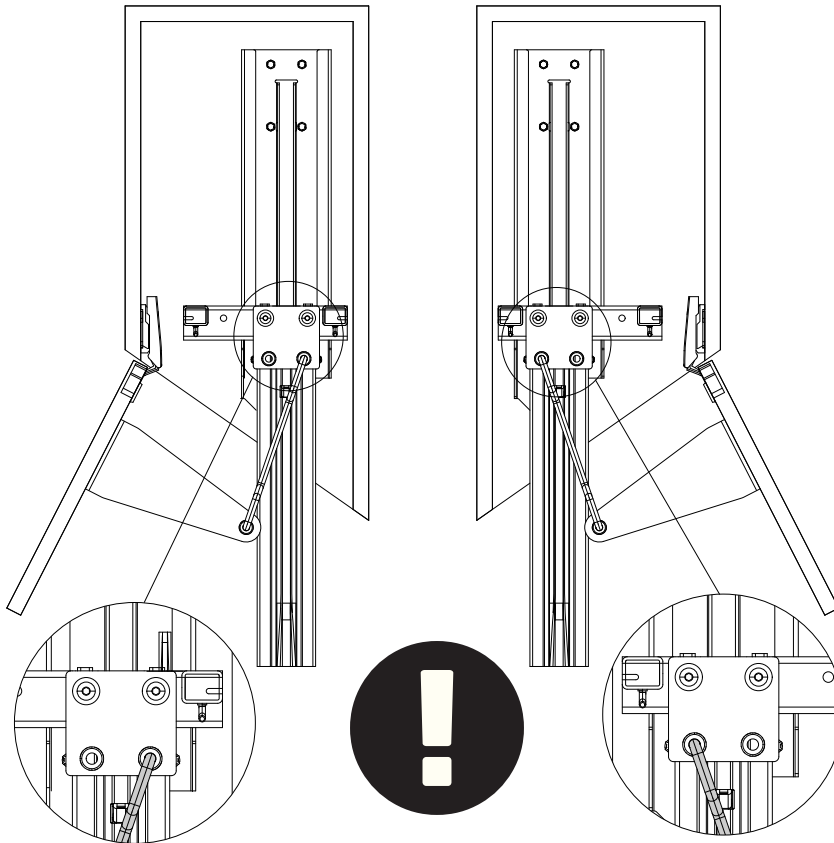

7

